

Thermistors Coated with Molecularly Imprinted Nanoparticles for the Electrical Detection of Peptides and Proteins

K. Betlem¹, F. Canfarotta², R. Raumbault³, C.E. Banks⁴, K. Eersels⁵, B. van Grinsven⁵, T.J. Cleij⁵, R. Crapnell⁴, A. Hudson⁶, M. Peeters^{6}*

1) Université Libre de Bruxelles, Experimental Soft Matter and Thermal Physics group, Physics division, Campus de Plaine, Boulevard du Triomphe, B-1050, Brussels, Belgium.

2) MIP Diagnostics Ltd., The Exchange Building, Colworth Park, Sharnbrook, MK44 1LQ, Bedford, United Kingdom.

3) Université Paris 13, IUT de Saint-Denis, Place du 8 Mai 1945, 93200 Saint-Denis, France

4) Manchester Metropolitan University, Department of Natural Sciences, John Dalton Building, Chester Street, M1 5GD Manchester, United Kingdom.

5) Maastricht University Maastricht Science Programme, P.O. Box 616, 6200 MD Maastricht, the Netherlands.

6) Newcastle University, School of Engineering, Merz Court, Claremont Road, NE1 7RU, Newcastle Upon Tyne.

Abstract:

In this communication, molecularly imprinted nanoparticles (nanoMIPs) that are produced by solid-phase synthesis are functionalised onto thermistors *via* dip-coating. These thermistors are soldered onto a printed-circuit board to facilitate electrical detection. Subsequently, these are inserted into a home-made thermal device that can measure the selective binding of biomolecules to the nanoMIP layer via monitoring the thermal resistance (R_{th}) at the solid-liquid interface. This thermal analysis technique, referred to as the Heat-Transfer Method, has previously been used for detection of proteins with MIP-based binders. While offering the advantages of low-cost and label free analysis, this method is limited by the high noise on the feedback loop and not being commercially available. These disadvantages can be overcome by the use of thermistors, which offer superior temperature sensitivity compared to thermocouples, and its electrical read-out can be easily integrated into portable devices. To our knowledge, this is the first report where MIPs are directly integrated onto thermistors for detection purposes. Measurements were conducted with an epitope of epidermal growth factor receptor (EGFR) and trypsin, where the electrical resistance was correlated to the biomolecule concentration. For both EGFR and trypsin, an enhanced signal to noise ratio for the electrical measurements

was observed compared to previous analysis that was based on thermal resistance. The sensitivity of the sensors in buffered solution was in the nanomolar range, which is compatible with physiologically relevant concentrations. Upon exposure of the nanoMIP for EGFR towards pepsin no significant change in the resistance was yielded, establishing the selectivity of the developed sensor platform.

Besides the enhanced sensitivity, the use of thermistors will enable miniaturisation of the device and has potential for *in vivo* measurements since specified electrochemical measurements are compatible with human use. To highlight the versatility of the nanoMIPs, this work should be extended to a set of biomolecules with various structures, with the possibility of extending this to an array format.

Corresponding author*:

Dr Marloes Peeters (marloes.peeters@newcastle.ac.uk)

Newcastle University, School of Engineering

Merz Court, Claremont Road, NE1 7RU, Newcastle Upon Tyne

Phone: +44 0191 208 8281

Keywords: Biomimetic sensors, Heat-Transfer Method (HTM), Molecularly Imprinted Polymer nanoparticles (nanoMIPs), thermistors, biomarkers, epidermal growth factor receptor (EGFR)

1. Introduction

The first report of the use of heat-transfer resistance at the solid-liquid interface as a tool for medical diagnostics was described by van Grinsven *et al.*, in 2012, who monitored mutations in DNA using thermal analysis [1]. This detection technique, which was coined the Heat-Transfer Method (HTM), has the advantages of low-cost and label-free analysis. In subsequent years, the methodology was expanded to determining concentrations of small organic molecules and cells using Molecularly Imprinted Polymers (MIPs) as recognition elements [2,3]. MIPs are synthetic mimics of antibodies that have high affinity for their respective template while offering significant advantages over natural receptors including better cost-effectiveness, superior thermal and chemical stability, and straightforward production process [4, 5]. For the thermal sensing of small molecules, MIP microparticles were used; however, they have inherent drawbacks such as their low affinity, template leaching, and heterogeneous binding site distribution [6]. The sensitivity of these sensors was significantly improved by

replacing these microparticles with molecularly imprinted nanoparticles that were produced according to the solid-phase approach. This method relies on attaching the template, or an epitope thereof, to a solid support that is used as an affinity medium to obtain molecularly imprinted nanoparticles (nanoMIPs) with high affinity and a homogeneous binding site distribution [7]. Nanoparticles manufactured according to this method have also been proven to be biocompatible, which makes them extremely interesting for diagnostics and therapeutic applications [8]. The combination of these nanoMIPs with HTM enabled detection of small molecules and relevant biomarkers in the low nM range in buffered solutions and spiked serum samples [9,10]. However, there are several limitations to bringing sensors based on thermal detection to the medical diagnostics market including high uncertainty on thermocouple measurements used for analysis, incompatibility with current hospital infrastructure, and not being able to perform *in vivo* measurements. In this communication, we will replace thermocouples as transducer materials with thermistors, metals whose electrical resistance varies as a function of temperature. Compared to thermocouples, thermistors have a smaller dimension, lower cost, and high sensitivity over a specific temperature range [11]. There are few literature reports on using MIPs in combination with thermistors [12,13]. However, for all these cases, detection of the targets was done by monitoring enthalpy changes with thermistors and limits of detection were not below the micromolar range, which is not sufficient to determine biomarkers at physiologically relevant concentrations. We will demonstrate significant improvements in the sensitivity of the MIP-based sensors by directly functionalising the sensitive end of the thermistor with nanoMIPs. These functionalised thermistors will be inserted into a thermal device that was designed in-house to enable simultaneous HTM and electrical resistance measurements. As proof-of-concept, nanoMIPs designed for an epitope of epidermal growth factor receptor (EGFR) will be used [14]. EGFR is overexpressed on the membrane of cancer cells since this accelerates cell division [15]. It is a druggable target and there are several inhibitors, including EGFR tyrosine kinases inhibitors, on the market for cancer treatment. There is considerable interest in EGFR detection due to its potential use in early diagnosis of cancer [16].

We demonstrate in this communication, for the first time, that the use of thermistors leads to similar limits of detection compared to HTM but benefits include higher signal-to-noise ratio, only requiring a simple multimeter for analysis, and straightforward data interpretation. First results demonstrate that other biomarkers can be targeted by adapting the nanoMIP, making this is a versatile tool with high promise in the field of medical diagnostics.

2. Experimental

2.1 Consumables

Phosphate buffered saline (PBS) solutions were made using PBS tablets (Sigma, UK) and de-ionized water of resistivity of at least 18.2 M Ω cm. Chemicals and equipment for the synthesis and analysis of the EGFR and trypsin nanoMIPs are described by Canfarotta *et al.* [8, 14]. The EGFR epitope (amino acids 418–435, MW: 2005 g/mol) was obtained from Ontores Biotechnologies (China). Pepsin and trypsin were purchased from Sigma (UK). The synthesis nanoMIP procedure is schematically shown in Supporting Information S-1.

In short, the nanoMIP preparation is as follows: to attach EGFR to the solid-phase, activated glass beads were placed in a solution containing succinimidyl iodoacetate linker which enables coupling of the amine-derivatised solid-phase to the thiol group present in the selected EGFR epitope. After leaving the solution overnight and subsequent washing with acetonitrile and PBS solutions, these functionalised beads were added to a solution containing various acrylamide monomers that were polymerised (polymerisation time 1 h) by adding an ammonium persulfate solution and N,N,N',N'-tetramethylethylenediamine.

The polymerisation process for the trypsin nanoMIPs was similar, but the solid-phase was prepared by incubating silanised glass beads with a 7% glutaraldehyde solution. After washing the beads with distilled water, trypsin was added and the beads were incubated overnight at 4°C.

2.2 Set up for thermal and electrical measurements

The thermistor used in this experiment was a MicroBetaCHIP thermistor from Farnell (Leeds, United Kingdom), which is a negative temperature coefficient thermistor that has the advantage of fast response time and working in a wide temperature range (-40 °C - 125 °C). These miniature thermistors consist of a lead wire, which is composed of nickel bifilar and insulated with polyester, that is potted into a polyimide tube with a thermally conductive epoxy. At first, a calibration curve was constructed to link the resistance to the temperature. Subsequently, the thermistor wires were applied to a nanoMIP solution in water for 60 s and withdrawn at a rate of 5.1 cm min⁻¹, which is in line with the procedure that our group previously used for thermocouple functionalisation [10]. Following at least 2h of air drying, the calibration curve was repeated to determine whether the thermistors exhibited the same temperature dependence.

Figure S-2 demonstrates that the temperature dependence is not affected by the presence of nanoMIPs on the tip of the thermistor.

Subsequently, these functionalised thermistor wires were inserted into an additively manufactured (3D printed) flow cell that was coupled to in-house designed thermal device [1]. The flow cells were sealed off with a copper block that serves as a heat-sink. Its temperature (T_1) was steered with a proportional-integral-derivative controller that was connected to the power resistor attached to the copper. The temperature of the liquid at fixed position T_2 was measured by a thermocouple. It is crucial to monitor the temperature signal (measurement every second) within the flow cell to determine that changes at the interface are due to binding of the biomolecules to the MIP layer instead of changes in the temperature within the flow cell. For all measurements, T_1 was controlled at strictly 37.00 ± 0.02 °C to mimic biological conditions. The experimental set up is schematically shown in Figure 1.

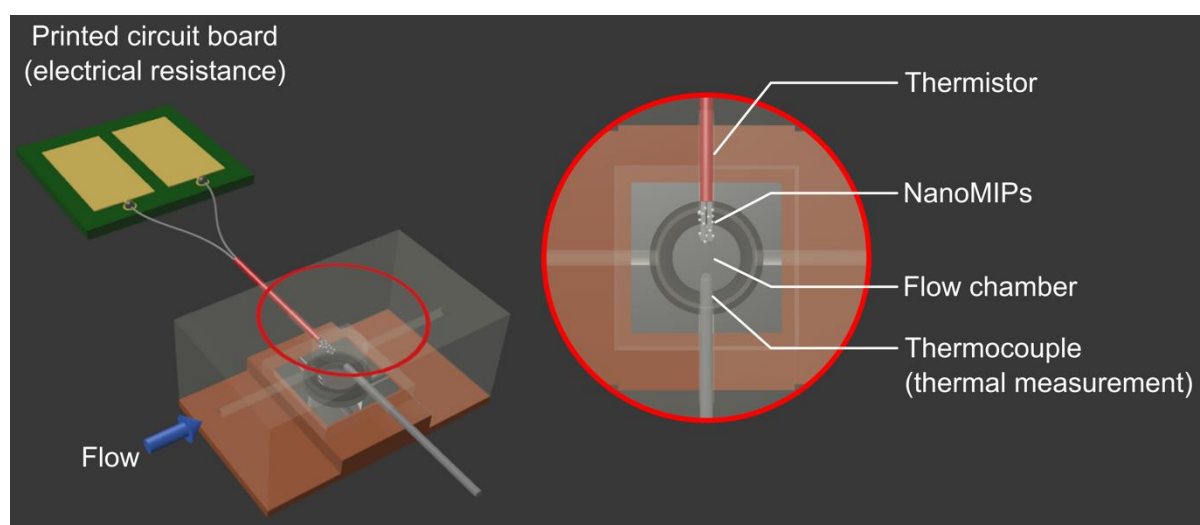

Fig 1. The modified HTM set up that can simultaneously measure the electrical resistance of the functionalised thermistor and the thermal resistance at the solid-liquid interface

In previous work, the biomolecule concentration was correlated to the thermal resistance at the solid-liquid interface of a MIP-functionalised thermocouple or a functionalised electrode [17]. The thermal resistance (R_{th}) was determined by dividing the temperature gradient ($T_2 - T_1$) over the power required to keep the heat sink at the set temperature of 37°C. The power is taken into consideration because it eliminates external influences, which have an impact on the

measurements due to the non-adiabatic nature of the flow cell. Simultaneously with these measurements, the electrical resistance is monitored every second with a RS Pro IDM8341 bench digital multimeter (Corby, UK) which is possible since the thermistor is soldered onto a printed circuit board.

2.3 Thermal and electrical measurements

In all measurements, the flow cells were filled with a solution of PBS and left for at least 30 min to ensure stabilisation of the baseline temperature signal. Solutions (2.5 mL) of EGFR or trypsin (0 – 500 nM) were prepared in PBS (pH = 7.4) and added at 100 μ L/min to the flow cell with an automated NE500 programmable syringe pump (ProSense, Oosterhout, the Netherlands). At least 20 min was allowed between sample additions to ensure stabilisation of the functionalised thermistor was positioned opposite of the thermocouple that measures T_2 . This experiment was performed with both the functionalised thermistor and with a “bare” thermistor to demonstrate that measured changes in electrical resistance can be attributed to binding of the target to the MIP layer. A thermocouple, positioned opposite of the thermistor, was used to determine the stability of the temperature signal within the flow cell and to show that changes in the electrical resistance are not caused by changes in properties of the liquid. The selectivity for the nanoMIP designed for EGFR was evaluated by first exposing the MIP to a PBS solution of pepsin (250 nM) followed by a PBS solution of EGFR (250 nM).

3. Results

3.1 EGFR measurements

At first, a measurement with a bare (non-functionalised) thermistor was conducted to determine the influence of additions of PBS solutions containing an epitope of EFGR and trypsin on the electrical resistance and the temperature within the flow cell (Figure S-3). From Figure S-3, a distinct difference was observed between the noise on the thermal signal vs the electrical resistance measured by the thermistor. The thermal resistance stabilised at 4.32 ± 0.05 $^{\circ}$ C/W, with a coefficient of variation of \sim 1% that is in line with previous literature reports [17]. The noise levels are relatively high compared to commercial equipment and work by Geerets *et al.*, has demonstrated that this can be attributed to fluctuation in the power that is required to keep the heat sink at a fixed temperature [18]. For the thermistors, the standard deviation was determined during the same interval and values of only 0.02% were obtained. Since the limit of detection is directly related to the standard deviation on the baseline signal, this means higher

sensitivity could be expected with thermistors compared to previous measurements based on the thermal resistance.

Upon injecting PBS solutions spiked with an epitope of EGFR, sharp increases in the thermal resistance were observed. This can be attributed due to solutions at ambient temperature being injected into the flow cell that is at 37°C, but upon stabilisation the signal returned back to baseline. There was no significant increase in the R_{th} , which is expected since there are no MIP cavities for the peptide to bind. The thermistors demonstrated a slight increase, from 6196 to 6201 Ω , which can be attributed to non-specific adsorption to the thermistor surface or change in thermal conductivity of the solution due to biomolecules being present. This might not be picked up by the thermal resistance signal due to the higher noise on the signal.

Subsequently, identical measurements were conducted using thermistors functionalised with nanoMIPs for EGFR (Figure 2). Contrary to the measurements with the blank, Figure 2 demonstrates a significant increase in the electrical resistance as one would expect when target molecules bind to the MIP layer. There was no significant difference in the temperature measured by the (non-functionalised) thermocouple at position T_2 that could affect the electrical resistance, validating that changes measured by the thermistor were attributed to binding to the MIP layer instead of temperature changes within the flow cell.

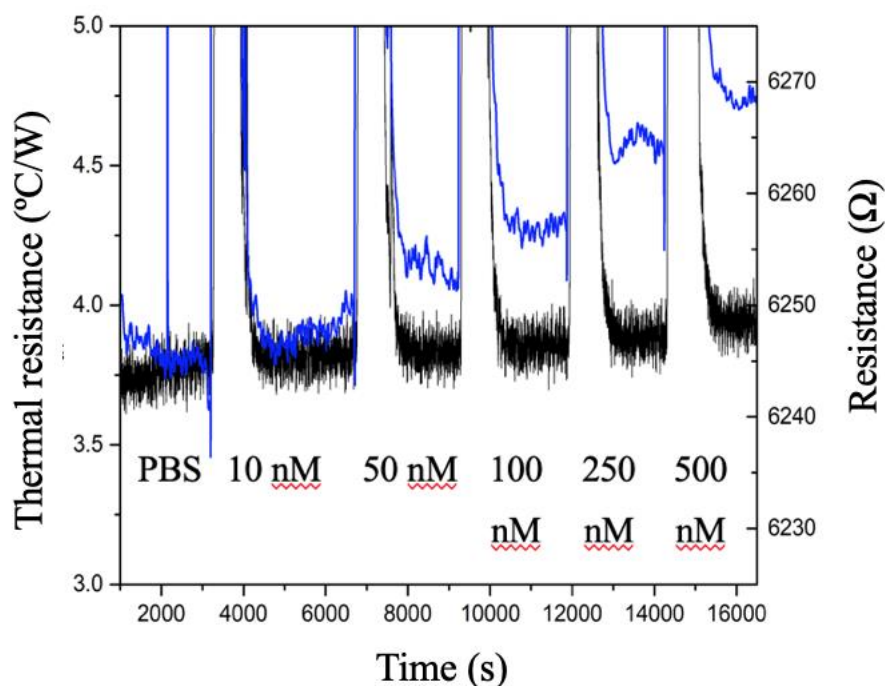

Figure 2. Measurements of the thermal (black line) and electrical (blue line) resistance over time upon addition of PBS solutions containing EGFR (0 – 500 nM). The thermocouple was used as such, the thermistors were functionalised with nanoMIPs for EGFR.

The thermal resistance stabilised at 3.75 ± 0.05 °C/W with a measured electrical resistance of 6245 ± 1 Ω. This is in a similar order to the blank but it could be there is a slight increase in the measured resistance due to the presence of the nanoMIPs; it should be noted that the particles are only expected to be at the measurement tip. Upon addition of 500 nM of an epitope of EGFR in a PBS buffer, the thermal resistance increased slightly but not above the noise of the thermal resistance.

When binding of biomolecules to MIP-functionalised thermocouples occurred, an increase in the thermal resistance at the solid-liquid interface was observed which can be explained by the “pore blocking model” [2]. It is expected that binding of the template of interest to the nano-MIP functionalised thermistor will follow the same trend as the thermocouples and binding of the template to the MIP layer will result in an overall increase in the electrical resistance.

As Figure 2 shows, the resistance of the thermistor went up by 23 Ω, which is significantly higher than the increase by 5 Ω that was recorded by the blank measurements. That corresponded to an increase of 0.3%, which is twenty times the noise on the signal. Significant changes in the resistance were measured upon additions of 10 nM of an epitope of EGFR in PBS or higher. This limit of detection is similar to what was previously obtained with functionalised thermocouples [10] and in line with enzyme-linked immunosorbent assays, the standard method to determine EGFR [19]. It is expected that with optimisation of the functionalisation procedure, it is possible to improve the sensitivity compared to thermocouples due to the overall lower noise on the thermistor.

In order to evaluate the reproducibility, this measurement was repeated. To this end, the tip of the thermistor was cleaned with ethanol and nanoMIP functionalisation was repeated. The response in electrical resistance as a function of the EGFR concentration, where the error bars correlate to the standard deviation on three independent measurements, is shown in Figure S-2. Up until 100 nM, a similar pattern was observed with respective increases of 15 ± 1 Ω vs 17 ± 1 Ω at this concentration. While measurements up until that point were in agreement, slight deviations (± 5 Ω) at higher concentration were observed which could be due to differences in

available binding sites on the surface. Due to the nature of the functionalisation procedure, it is difficult to control the amount of nanoMIP present on the tip, which could significantly affect the maximum binding capacity and thereby the binding at higher concentration.

3.2 Trypsin measurements

To demonstrate the versatility of this approach, nanoMIPs designed for trypsin were deposited onto thermistors and measurements were performed with PBS solutions spiked with trypsin. Figure 3 demonstrates the electrical and thermal resistance over time, which shows a similar pattern compared to the experiments done with EGFR.

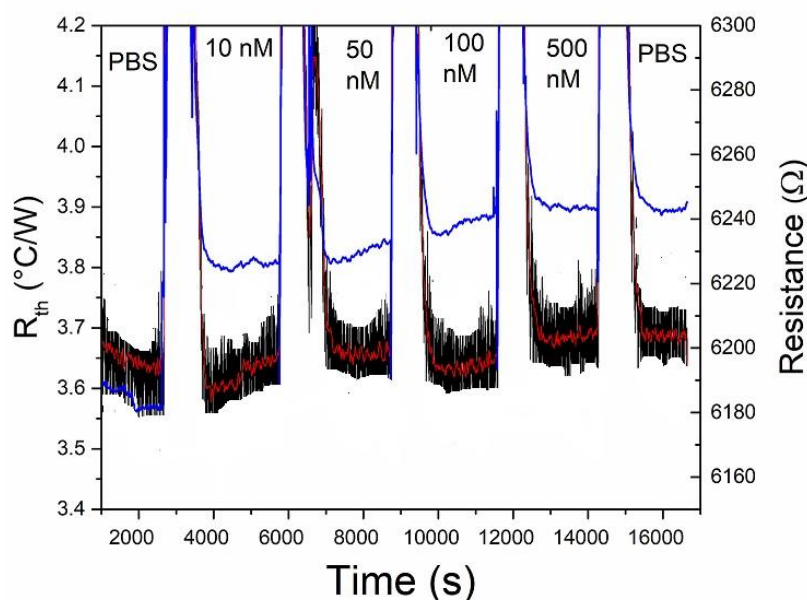

Figure 3. The thermal (black line) and electrical (blue) resistance measured by the thermistor functionalised with a nanoMIP for trypsin upon exposure to PBS solution containing trypsin.

The red line is a guide for the eye and a 600 pt average of the thermal resistance.

The thermal resistance did not significantly increase upon addition of 500 nM of trypsin in PBS. In contrast, there was a more pronounced change in the electrical resistance compared to EGFR, with a jump of around $40 \pm 10 \Omega$ upon exposure to a PBS solution spiked with 10 nM of trypsin. When increasing the concentration, the resistance gradually rose further with a total change of $50 \pm 2 \Omega$. The estimated limit of detection for this methodology was in the low nanomolar range, which is similar to what we have reported with functionalised thermocouples [10]. It is also in line with the dissociation constant (K_D) calculated for these nanoMIPs (8 nM). Additional data available in Figure S-1 demonstrates how this value was calculated using

surface plasmon resonance (SPR). An experiment (Supporting Information S-5) with a freshly prepared MIP-functionalised thermistor demonstrated this similar jump in the order between 35-40 Ω upon exposure of the thermistor towards a trypsin concentration of 10 nM in PBS, demonstrating the reproducibility of the sensor platform.

3.3 EGFR selectivity measurements

To further examine the selectivity of the EGFR nanoMIPs, an experiment was performed where the functionalised thermistors were first exposed to pepsin (250 nM in PBS), followed by flushing with PBS, and subsequent exposure to a solution containing EGFR (250 nM in PBS). The results of this experiments are shown in Figure 4. Pepsin is a digestive protein with a molecular weight of \sim 34.5 kDa [20], and was previously used to determine the selectivity of the nanoMIPs designed for EGFR. Thus, it will demonstrate whether binding is based on the specific sequence of amino acids, or whether other peptides will also bind to the nanoMIPs.

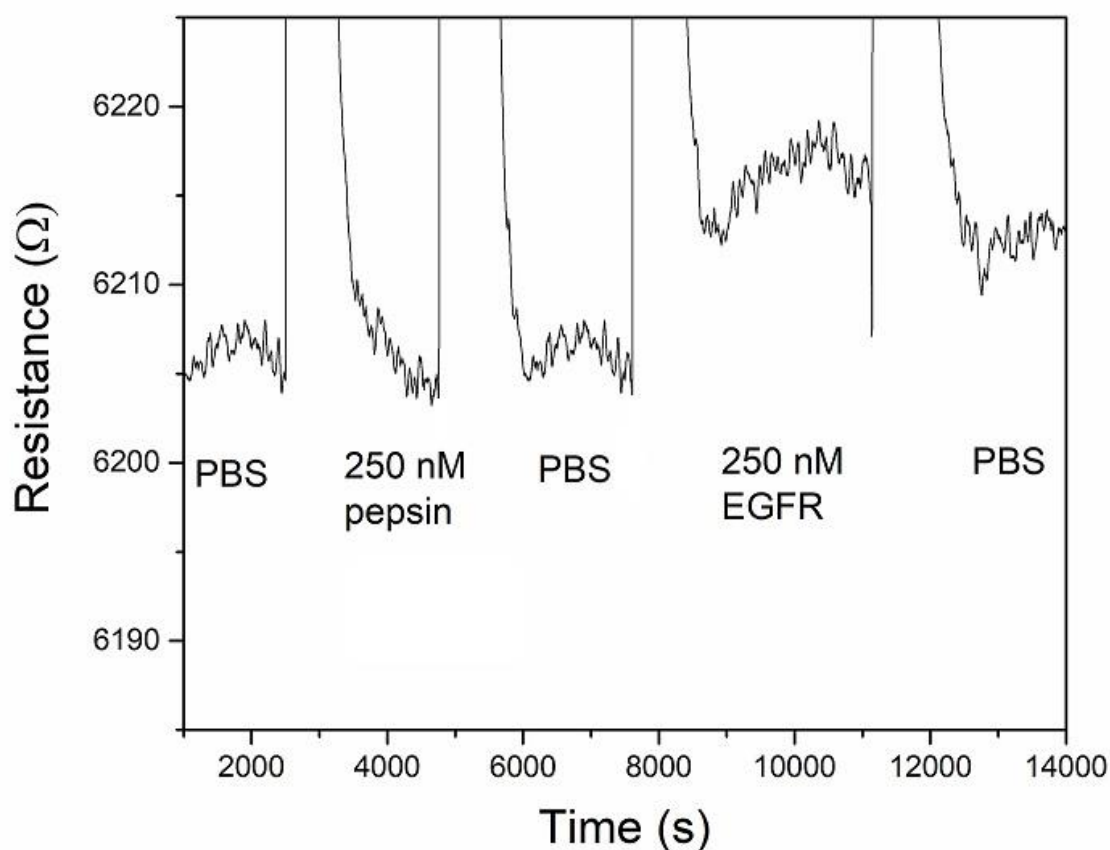

Figure 4. The electrical resistance measured by the thermistor functionalised with a nanoMIP for EGFR upon exposure to pepsin, PBS, and the template EGFR

The resistance stabilised at 6205 Ω in PBS and was not affected by the addition of a solution of PBS with pepsin. However, a notable increase of 10 Ω was observed upon addition of a solution containing EGFR. This is somewhat lower compared to the measured response in Figure 2; however, it has to be noted that the presence of (residual) pepsin and potential binding of pepsin to the nanoMIP layer might impact binding of EGFR. Nonetheless, it is clear that the response was only observed upon exposure of the nanoMIP to its original target, which is a first proof for the selectivity of the polymer layer.

The selectivity of the nanoMIP designed for trypsin was evaluated with biotin, another protein that is involved in the metabolism of enzymes. As shown in Figure S-6, upon exposure of the functionalised thermistors to PBS solutions with concentrations up to 500 nM of biotin no significant response in the electrical resistance was observed, thereby providing additional proof of selectivity of the developed sensors.

4. Conclusions

This work is the first report of a polymer-based sensing platform using MIP-functionalised thermistors as working electrodes. Dip-coating was used to attach the nanoMIPs onto the sensitive tip of a negative temperature coefficient thermistor. The functionalised thermistor was attached to a printed circuit board and inserted into a flow cell, ensuring simultaneous measurements of the electrical resistance of the thermistor and of the thermal resistance at the solid-liquid interface. The flow cell was sealed off with a copper heat sink, which was kept at 37.00 ± 0.02 °C for all measurements to mimic body temperature. Experiments where the bare (non-functionalised) thermistor was exposed to PBS solution with increasing biomarker concentration (0-500 nM of an epitope of EGFR) did not show a significant difference in either the electrical or thermal resistance. In contrast, the thermistors that were functionalised with nanoMIPs designed for EGFR demonstrated an increase in the electrical resistance that was attributed to binding to the nanoMIP layer since there was no significant response in the temperature signal. A measurable increase was seen for concentrations of 10 nM which is in the same range as previously used thermocouples and immunoassays commonly employed for EGFR analysis. The use of thermistors over thermocouples, that were previously used for MIP-based detection of biomarkers, has the significant advantages of lower noise (0.02 vs 1%) and thereby higher signal to noise ratio. This experiment was repeated with a freshly prepared electrode, which demonstrated a similar signal in the lower concentration range. The selectivity of the sensor platform was established by comparing the response of the EGFR nanoMIP

functionalised thermistor in the presence of pepsin, a biomarker with similar properties. To demonstrate the versatility of the sensor platform, the same experiments were performed with nanoMIPs for trypsin. A limit of detection in a similar order for trypsin (10 nM) was obtained, which again is similar to commonly used immunoassays while offering lower noise compared to the use of the thermal resistance.

The use of thermal sensing in combination with MIP technology for detection of biomolecules has the advantages of straightforward and low-cost analysis. However, it has to be noted that the home-made device used for thermal analysis is not available in all labs with the technology in its infancy. Furthermore, it is difficult to miniaturise the device and it is not compatible with *in vivo* measurements due to the need of a temperature gradient. The sensor platform described in this communication has sensitivity on par with thermal analysis while offering miniaturisation and higher signal-to-noise. Therefore, when implemented into a portable device, this versatile technology can have high potential for use in biomedical research.

5. Acknowledgements

We would like to acknowledge the EPSRC for funding of the salary AH (EPSRC EP/R029296/1) and the Royal Society of Chemistry (Research Fund RF18-2881 of MP) for purchase of consumables.

6. References

- [1] B. van Grinsven, N. Vanden Bon, H. Strauven, L. Grieten, M. Murib, K.L. Jiménez-Monroy, S.D. Janssens, K. Haenen, M.J. Schöning, V. Vermeeren, M. Ameloot, L. Michiels, R. Thoelen, W. De Ceuninck, P. Wagner, *ACS Nano*, 2012, **6**, 2712.
- [2] M. Peeters, P. Csipai, B. Geerets, A. Weustenraed, B. van Grinsven, R. Thoelen, J. Gruber, W. De Ceuninck, T.J. Cleij, F. Troost, P. Wagner, *Anal. Bioanal. Chem.*, 2013, **405**, 6453.
- [3] K. Eersels, B. van Grinsven, A. Ethirajan, S. Timmermans, K.L. Jiménez-Monroy, J.F. Bogie, S. Punniyakoti, T. Vandenryt, J.J. Hendriks, T.J. Cleij, M.J. Daemen, V. Somers, W. De Ceuninck, P. Wagner, *ACS Appl. Mater. Interfaces*, 2013, **5**, 7258.
- [4] G. Wulff, *Chem. Rev.*, 2002, **102**, 1.
- [5] K. Haupt, *Analyst*, 2001, **126**, 747.
- [6] Y.Lei, P.A.G Cormack, K. Mosbach. *Anal. Chim. Acta*, 2001, **435**, 187.
- [7] F. Canfarotta, A. Poma, A. Guerreiro, S. Piletsky, *Nature Protocols*, 2016, **11**, 443.

- [8] A. Cecchini, V. Raffa, F. Canfarotta, G. Signore, S. Piletsky, M.P. MacDonald, A. Cuschieri, *Nano Letters*, 2017, **17**, 2307.
- [9] R. D. Crapnell, F. Canfarotta, J. Czulak, R. Johnson, K. Betlem, F. Mecozzi, M. P. Down, K. Eersels, B. van Grinsven, T. J. Cleij, *ACS Sensors* **2019**, 4, 2838
- [10] F. Canfarotta, J. Czulak, K. Betlem, A. Sachdeva, K. Eersels, B. Van Grinsven, T. Cleij, M. Peeters, *Nanoscale* 2018, 10, 2081.
- [11] K. Mosbach, B. Danielsson, *Biochimica et. Biophysica Acta (BBA)-Enzymology*, 1974, **364**, 140.
- [12] K. Lettau, M. Katterle, A. Warsinke, F.W. Scheller, *Biosens. Bioelectron.*, 2008, **23**, 1216.
- [13] R. Rajkumar, A. Warsinke, H. Möhwald, F.W. Scheller, M. Katterle, *Talanta*, 2008, **76**, 1119.
- [14] F. Canfarotta, L. Lezina, A. Guerreiro, A. Petukhov, A. Daks, K. Smolinksa-Kempisty, A. Poma, S. Piletsky, N.A. Barley, *Nano Lett.* 2018, **18**, 4641-4646.
- [15] M.J. Wieduwilt, M.M. Moasser, *Cellular and Molecular Life Sciences*, 2008, **65**, 1566.
- [16] A.F. Gazdar, J.D. Minna, *Cancer Prevention Research*, 2008, **1**, 156.
- [17] K. Betlem, I. Mahmood, R. Seixas, I. Sadiki, R. Raimbault, C. Foster, R. Crapnell, S. Tedesco, C. Banks, J. Gruber, *Chemical Engineering Journal* **2019**, 359, 505
- [18] B. Geerets, M. Peeters, B. van Grinsven, K. Bers, W. De Ceuninck, P. Wagner, *Sensors*, 2013, **13**, 9148.
- [19] H. Ilkhani, M. Sarparast, A. Noori, Z. Bathaie, M.F. Mousavia, *Biosens. Bioelectron.* 2015, **74**, 491
- [20] N.B. Roberts, *Aliment. Pharmacol. Ther.* 2006, **24**, 2.

Supporting Information S-1, Synthesized nanoMIPs and SPR data

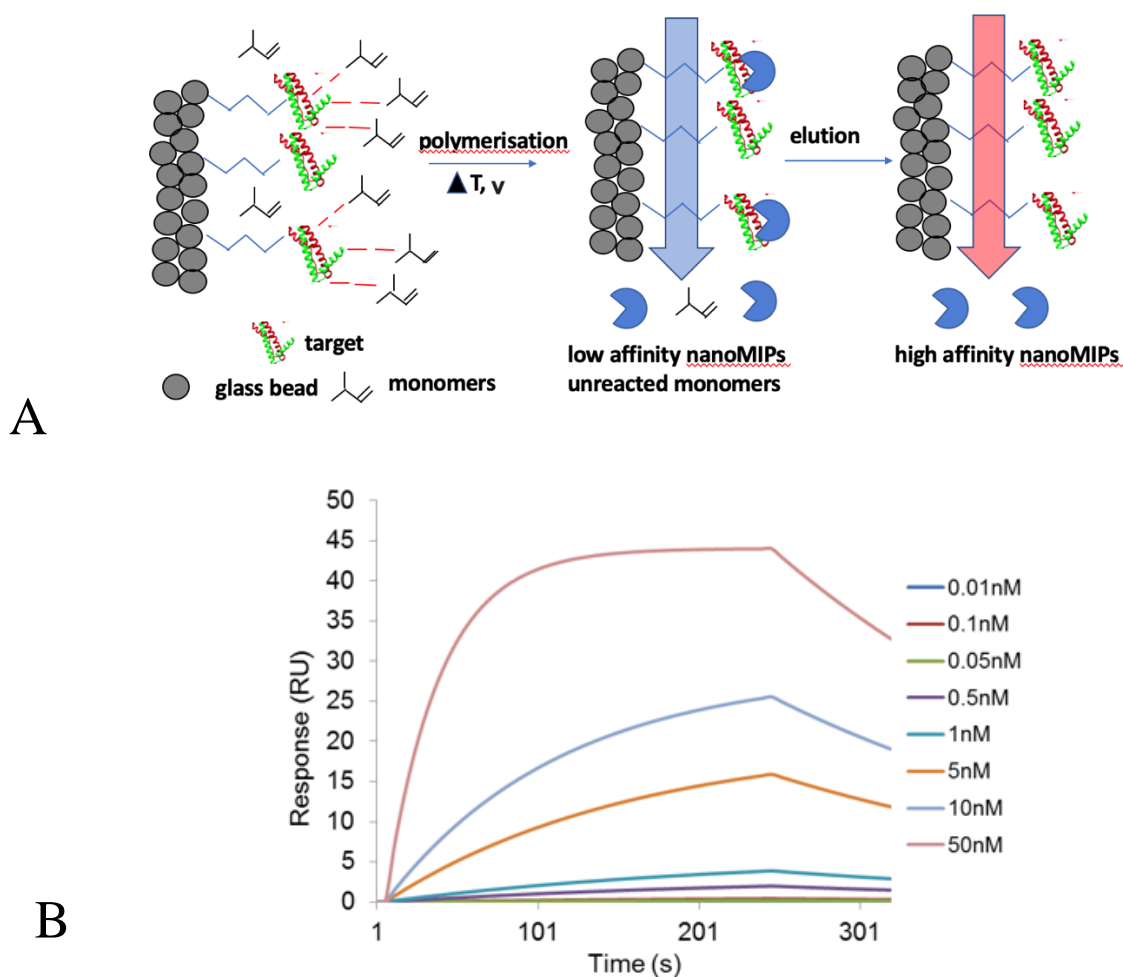

Supporting Information S-1: Scheme of the solid-phase synthesis of nanoMIPs (a). The SPR sensorgrams for the binding of the EGFR peptide epitope to immobilised anti-EGFR nanoMIP, from which the dissociation constant can be calculated, is shown in (b).

SPR analysis description: Analysis was performed on SIA Au SPR gold chips (GE Healthcare, UK) modified with mercaptoundecanoic acid (Sigma Aldrich). Bare gold chips were first cleaned by hydrogen plasma at 50 W during five minutes on an Emitech K1050X Plasma Cleaner (Emitech, UK) and then placed in ethanol containing 0.3 mg/mL lipoic acid and 5 % (v/v) acetic acid (Fisher Scientific), overnight in a sealed vial. After surface modification, chips were rinsed with ethanol and dried under a stream of N₂, assembled on the holder following the manufacturer instructions and docked onto the SPR instrument (Biacore 3000, GE Healthcare, UK). For polymer coupling, the chips were activated by injection of 100 μ l EDC 0.2 M and NHS 0.05 M (both from Sigma Aldrich) in water at 10 μ l/min, followed by 3-5 injections of nanoMIPs (0.1 mg mL⁻¹) in PBS at 15 μ l/min until 60-80 % surface capacity was reached. The same procedure was used on a different channel to immobilise biotin nanoMIPs, which were used as a control. Remaining NHS esters were deactivated by injection of 600 μ l of 0.1 M carbonate buffer pH 9.4 at 20 μ l min⁻¹. The EGFR peptide was then injected onto the nanoMIP-modified chip in concentrations ranging from 0.01 to 50 nM, and analysis was performed in 1 \times PBS at pH 7.4. Kinetic analysis of the sensorgrams was performed with the BiaEvaluation software v4.1 assuming a 1:1 Langmuir binding model. Chi² values for data reported are below 10 % of the respective instrument response.

S-2, Calibration curve for temperature dependence of thermistors

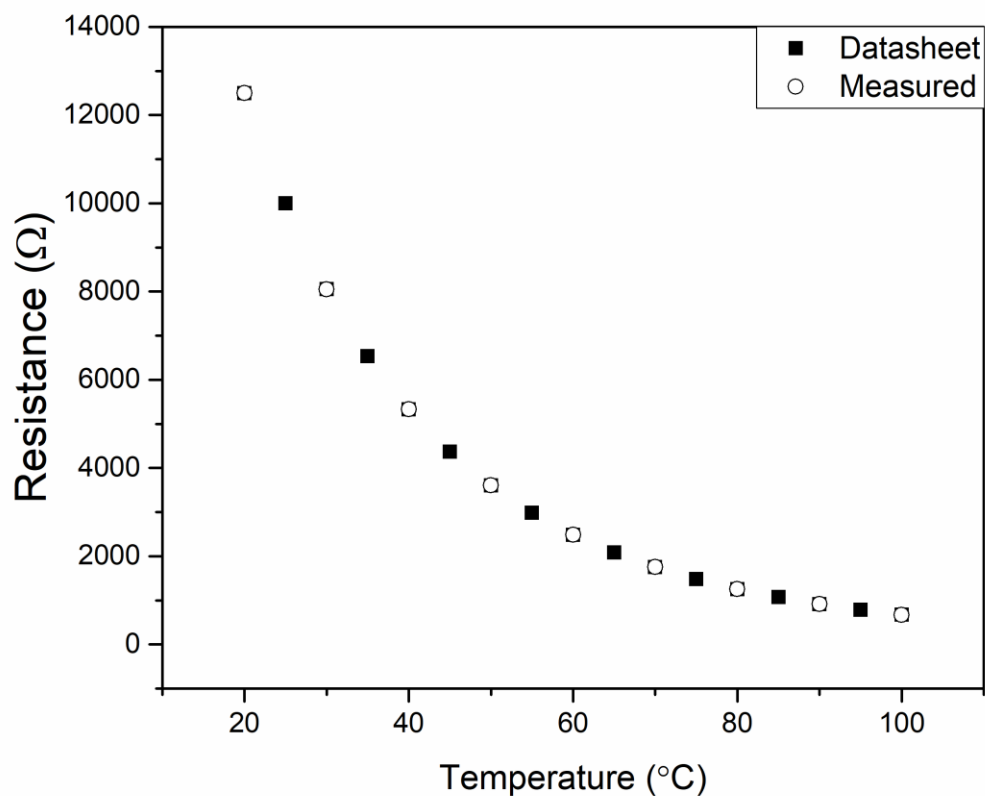

Figure S-2: The temperature of the thermistor according to the Farnell datasheet (filled squares) vs what was measured after functionalisation of the nanoMIPs (open squares). These measurements (open squares) were performed in triplicate but given the low error on commercial thermistors and minor influence of nanoMIP attachment, the standard deviation (0.02%) was smaller than symbol size.

S-3 Blank measurements for EGFR and trypsin

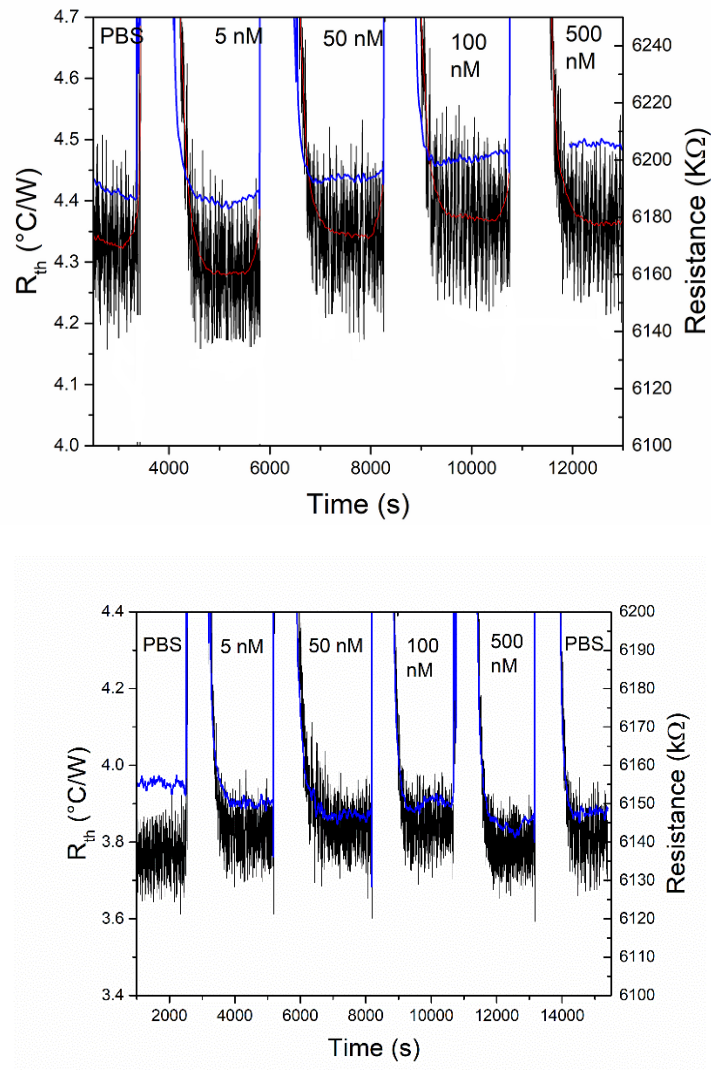

Figure S-3: a) The top image demonstrates the thermal resistance (black line) over time upon additions of PBS and PBS solutions containing EGFR. The red line corresponds to a median filter (taken over 60 points) of the thermal resistance. The blue line corresponds to the electrical resistance measured by the bare thermistor.

b) The bottom image demonstrates the thermal resistance (black) line over time upon additions of PBS and PBS solutions containing trypsin. The blue line again relates to the electrical resistance measured by the bare thermistor.

S-4 Measurement of an epitope of EGFR in PBS with a freshly prepared nanoMIP-functionalised thermistor

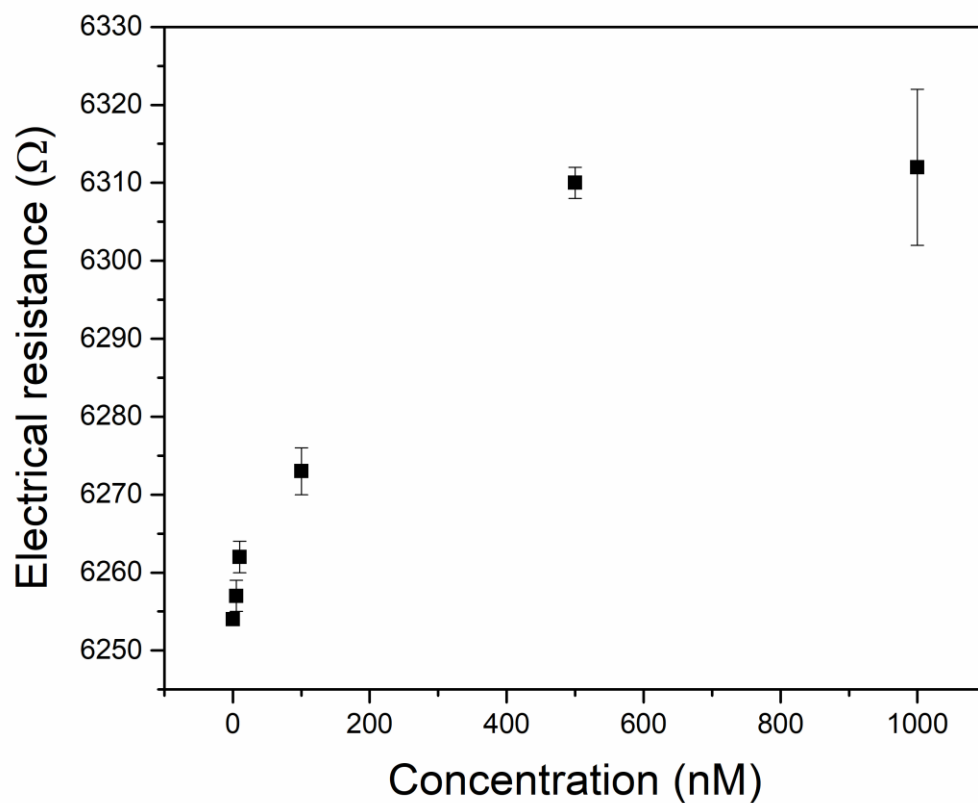

Figure S-4: The electrical resistance of the MIP-functionalised thermistor as a function of the concentration of an EGFR epitope in PBS solution. The error bar on the signal corresponds to the standard deviation of three independent measurements.

S-5 Measurements of trypsin in PBS with a freshly prepared nanoMIP-functionalised thermistor

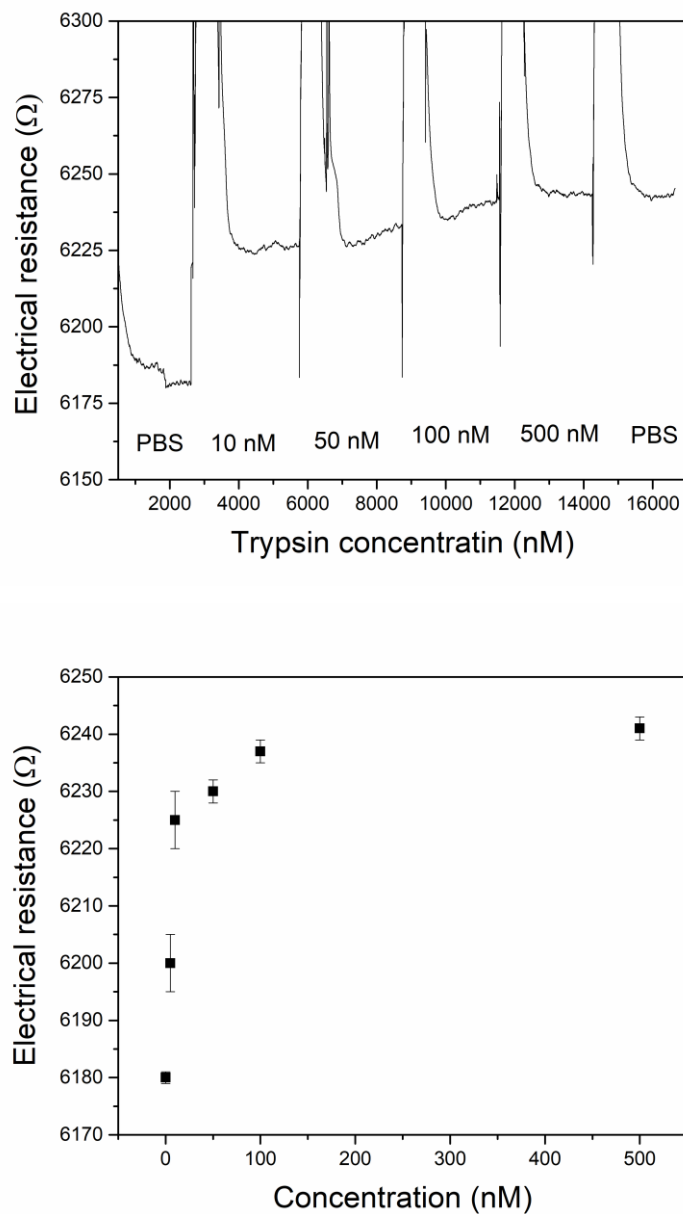

Figure S-5 The electrical resistance of the MIP-functionalised thermistor as a function of the concentration of trypsin in PBS solution (a). The dose-response curve, where error bars correspond to the standard deviation of three independent measurements, is shown in (b).

S-6 Selectivity experiments by exposing thermistor functionalised with nanoMIP for trypsin to PBS solutions with increasing biotin concentration

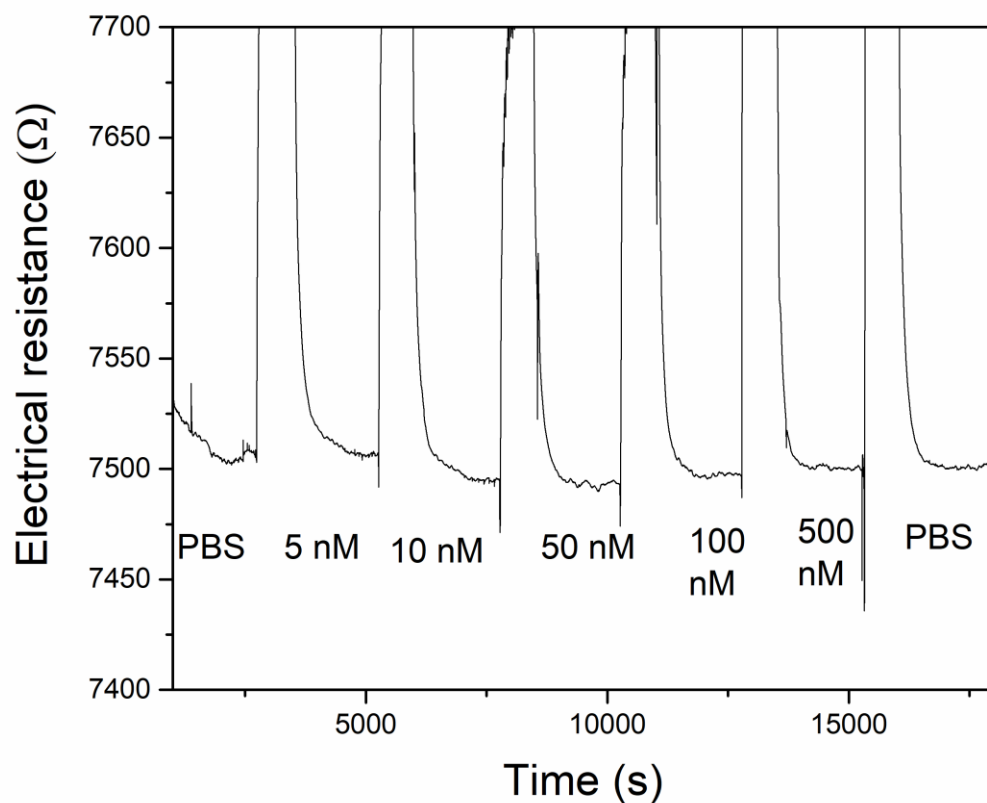

Figure S-6 The selectivity of the nanoMIP for trypsin was evaluated by exposing the functionalised thermistors to PBS solutions with increasing concentrations of biotin (0-500 nM).